

# Variantenstudie fietsbrug over de Hollandsche IJssel



Door:

- Hans van Engelenburg : projectmanager doorfietsroutes Provincie Utrecht
- Robert Kanon : projectleider kunstwerken Provincie Utrecht
- Chris Wattel : architect ipv Delft

Datum: 19 januari 2023

## Deel 1 - Hans

### Inhoud presentatie

Deel 1 - Hans:

Aanleiding

Samenwerking provincie en gemeentes

Doorfietsroutenetwerk Utrecht

Locatie

Deel 2 - Robert:

Zoekgebied

Omgevingsanalyse

Type brug

Schetsontwerp

Deel 3 - Hans:

Hoe nu verder

Vragen

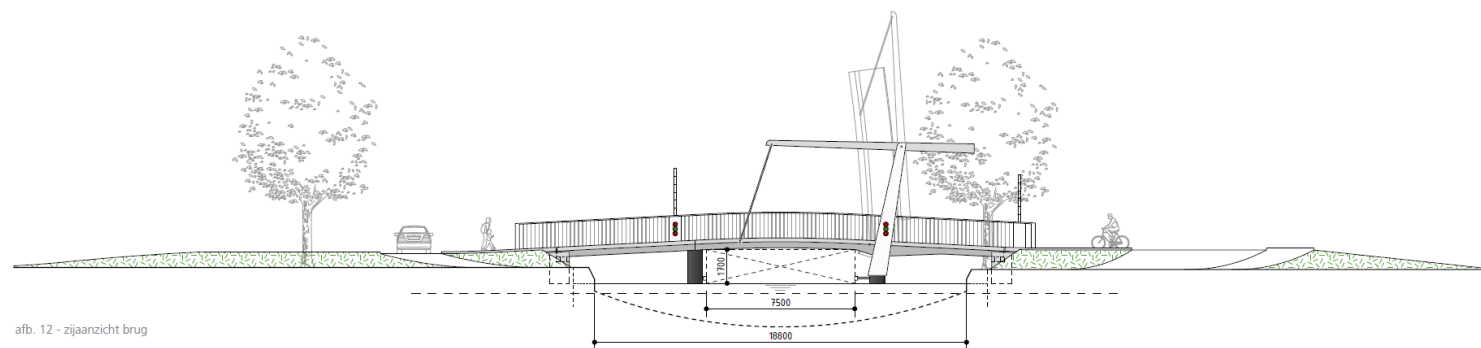

## Aanleiding voor variantenstudie en schetsontwerp

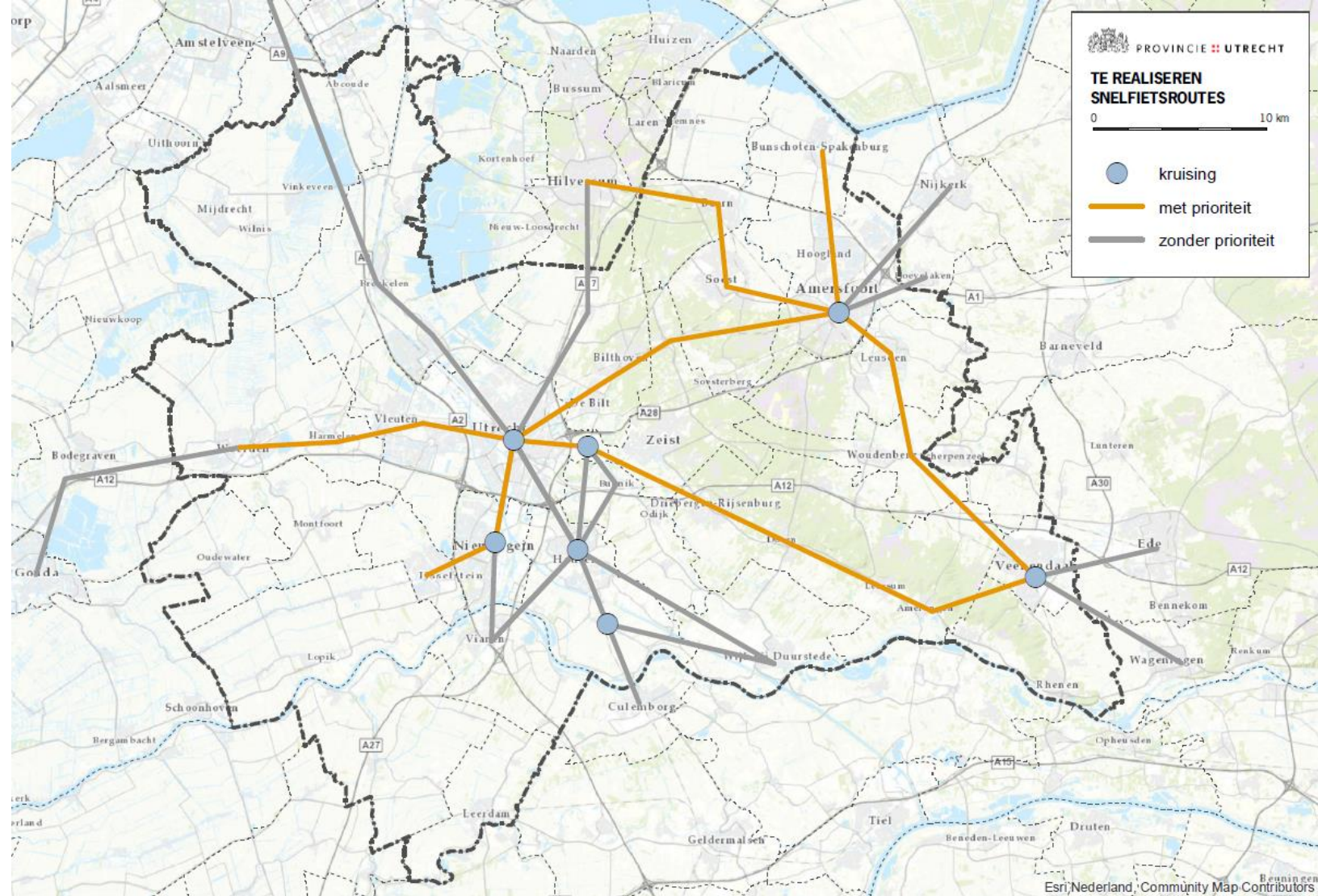

PROVINCIE  UTRECHT

Nieuwegein



Gemeente

**IJsselstein**

verbeterde routes

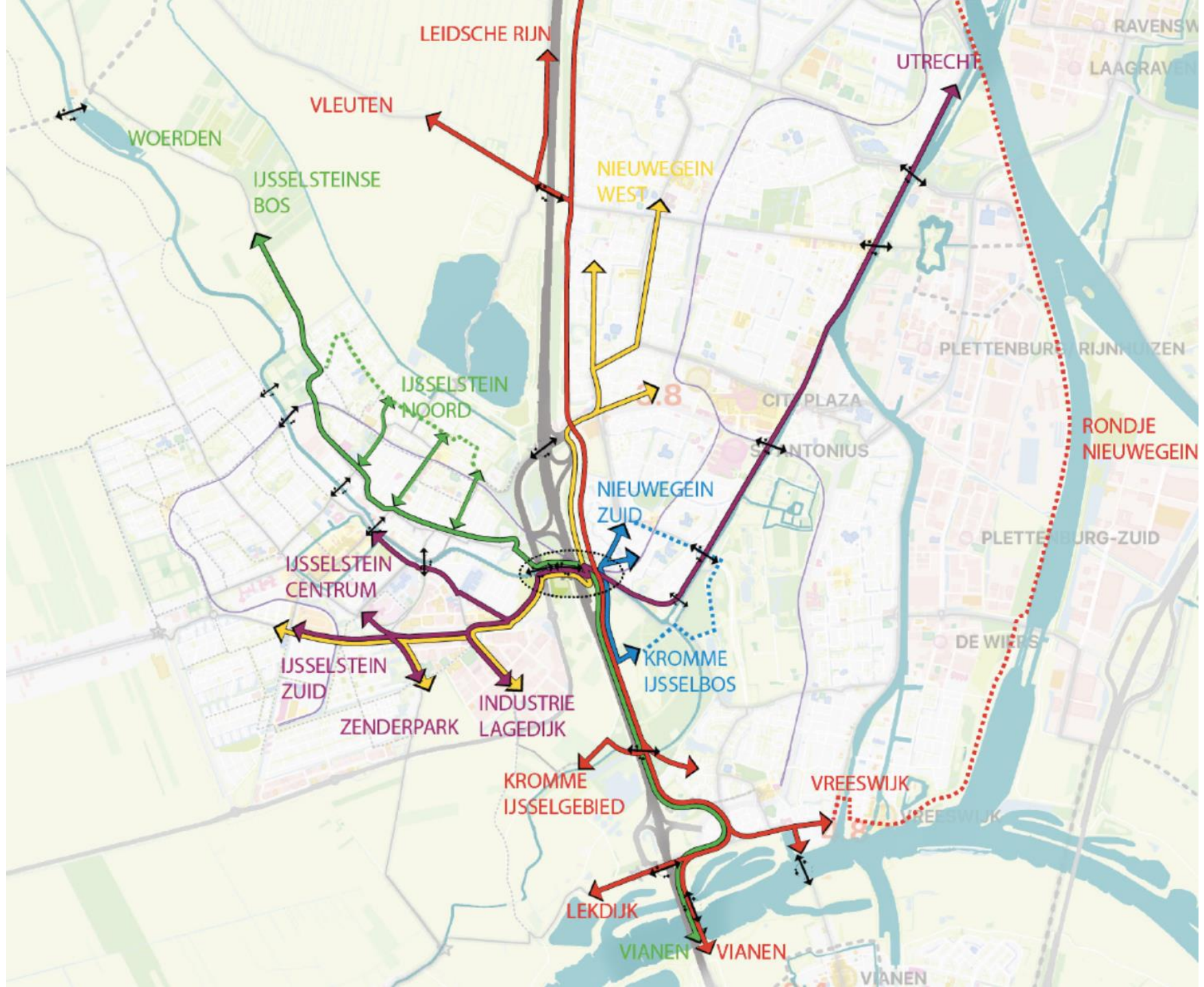

zoekgebied

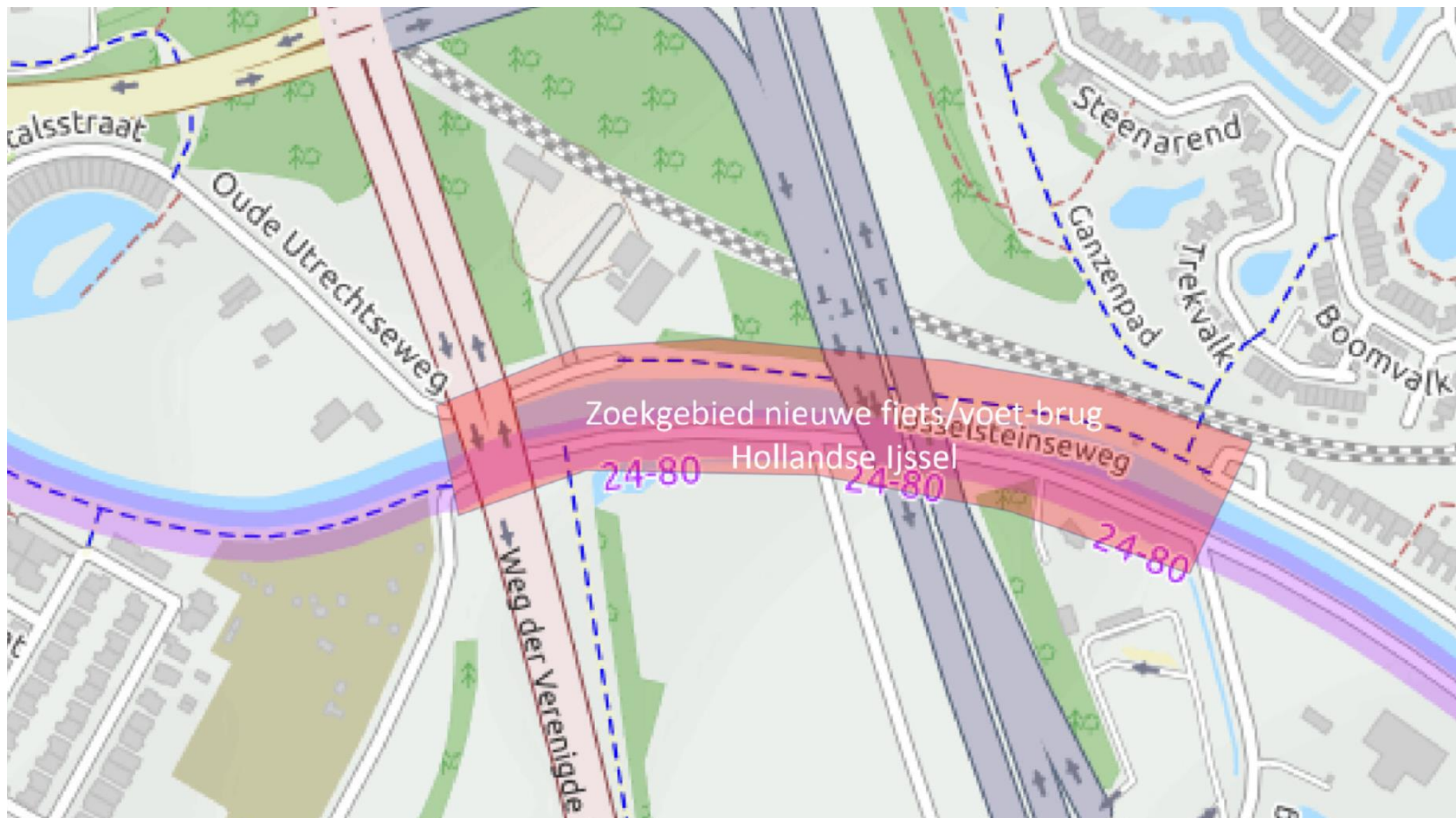



foto's locatie

Deel 2 - Robert

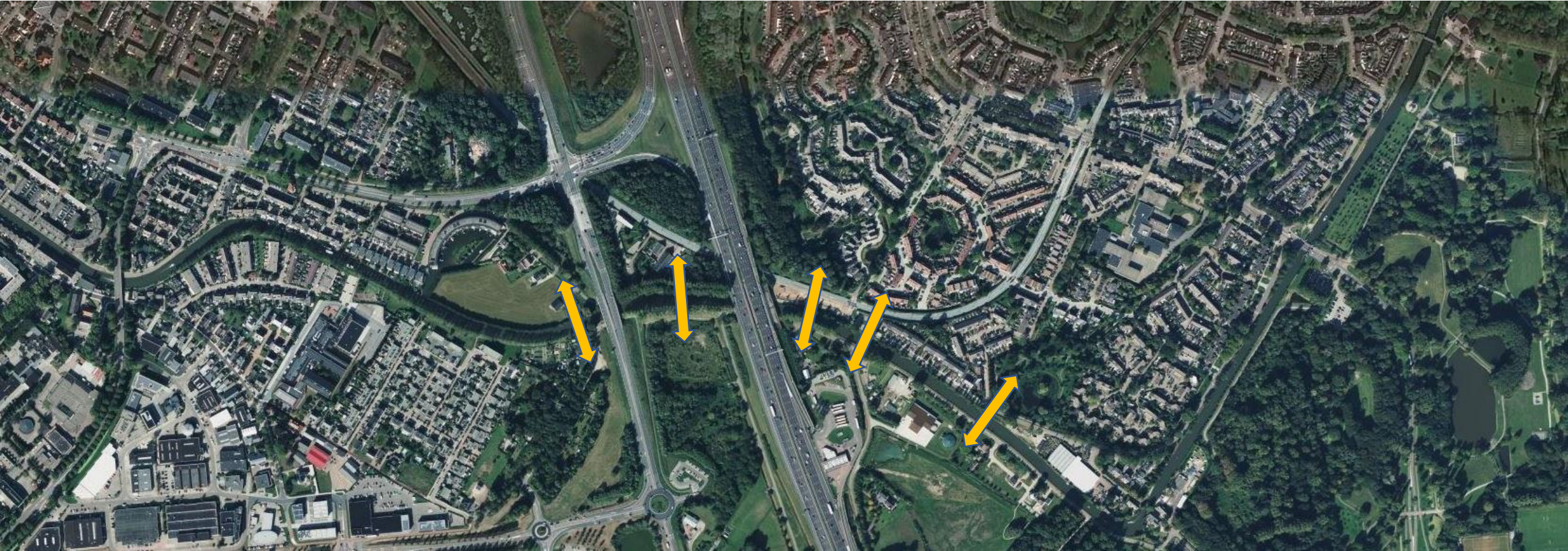

zoekgebied

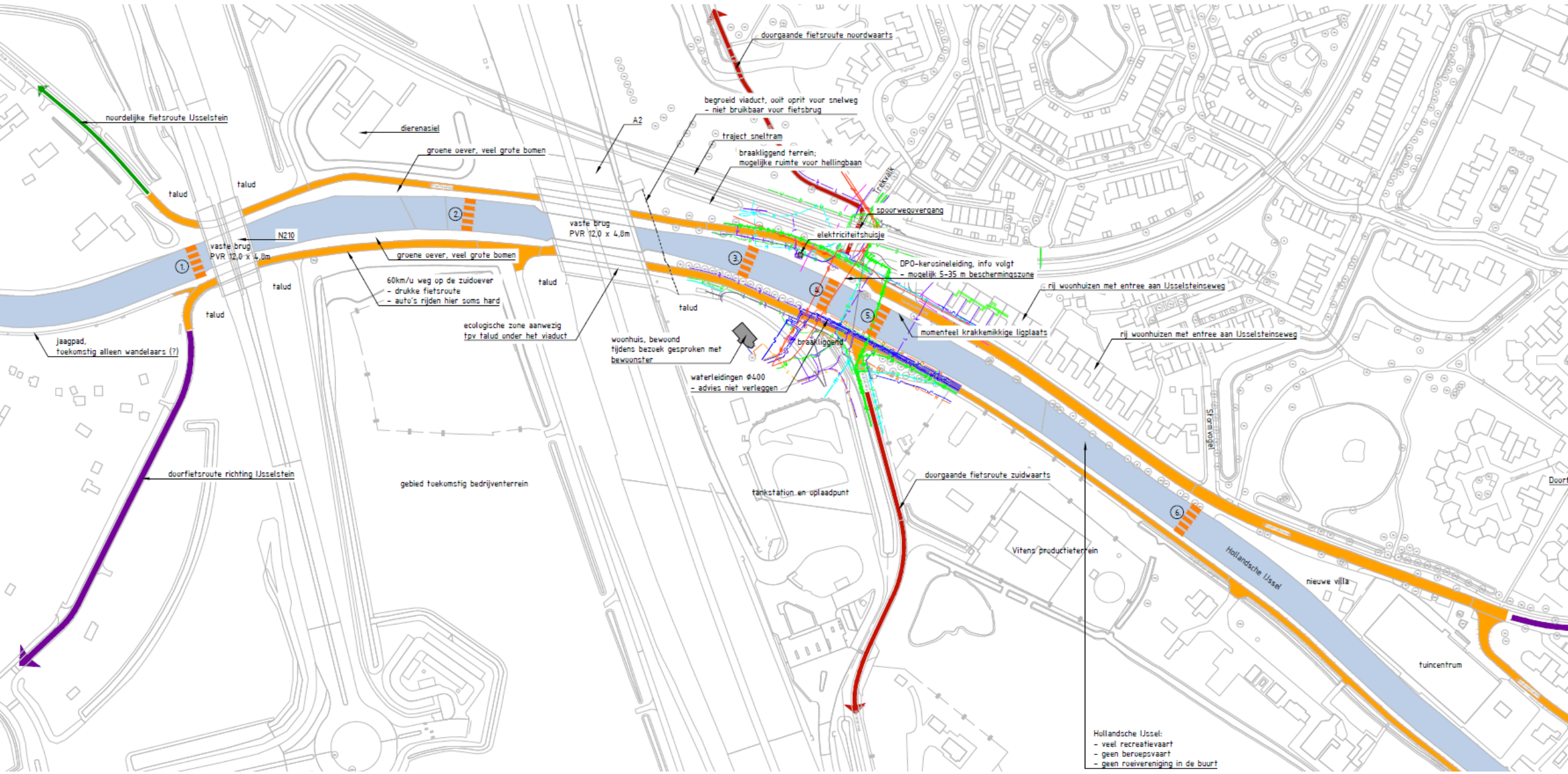

Hollandsche IJssel:  
 - veel recreatievaart  
 - geen beroepsvaart  
 - geen roeivereniging in de buurt

aandachtspunten omgeving



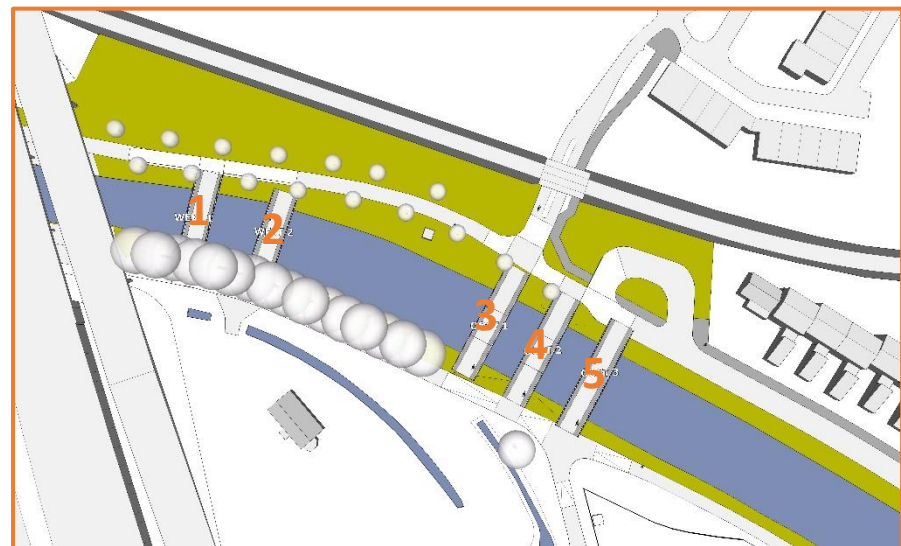

overzicht locaties

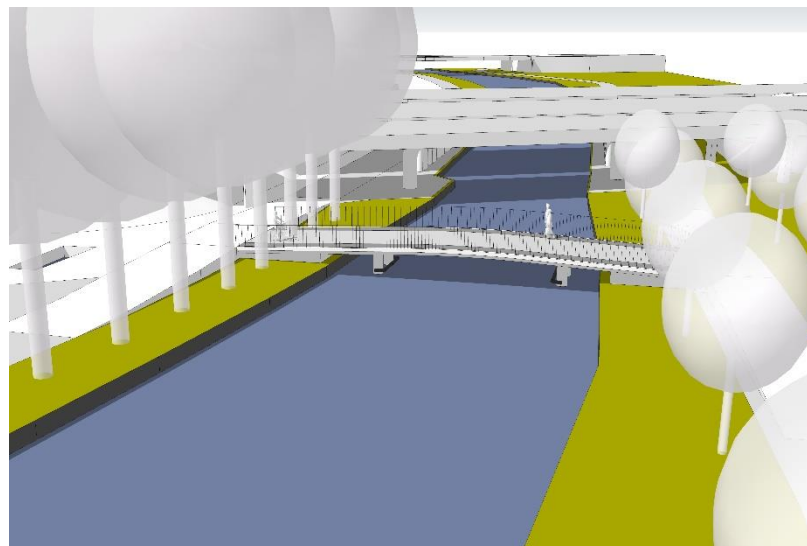

1. naast viaduct

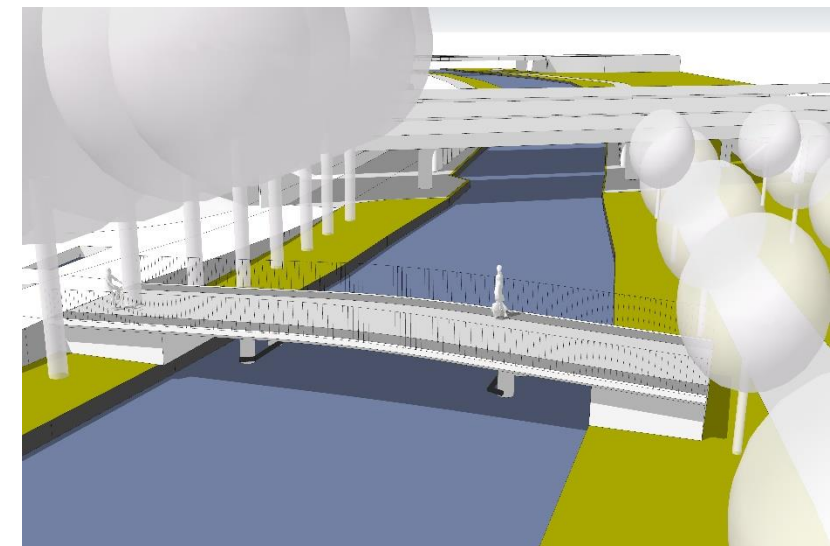

2. ter plaatse van inrit woonhuis

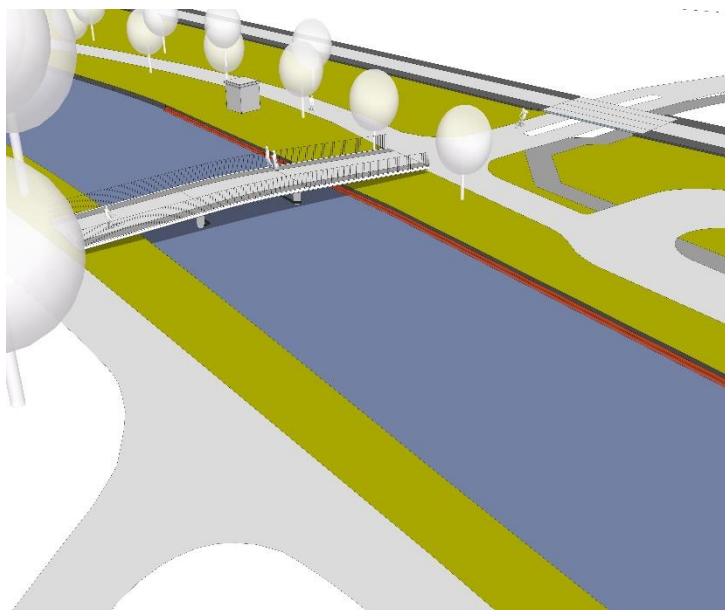

3. in verlengde van spoorwegovergang

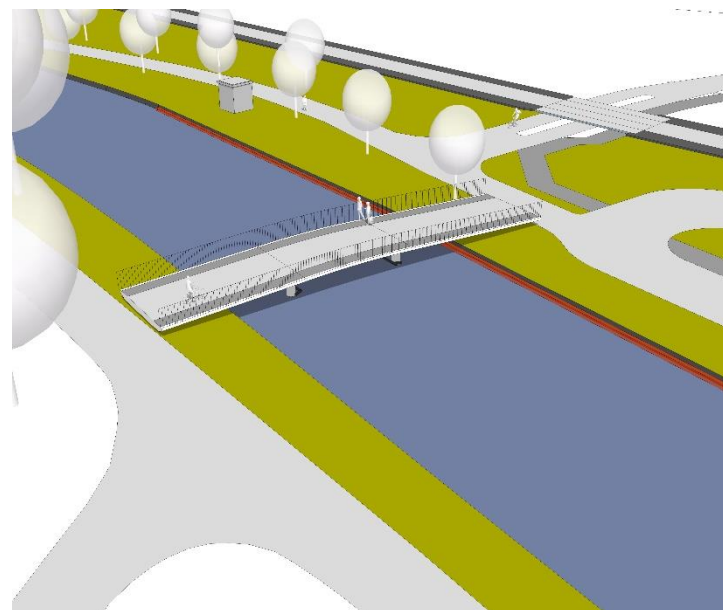

4. tussen overgang en zijstraat

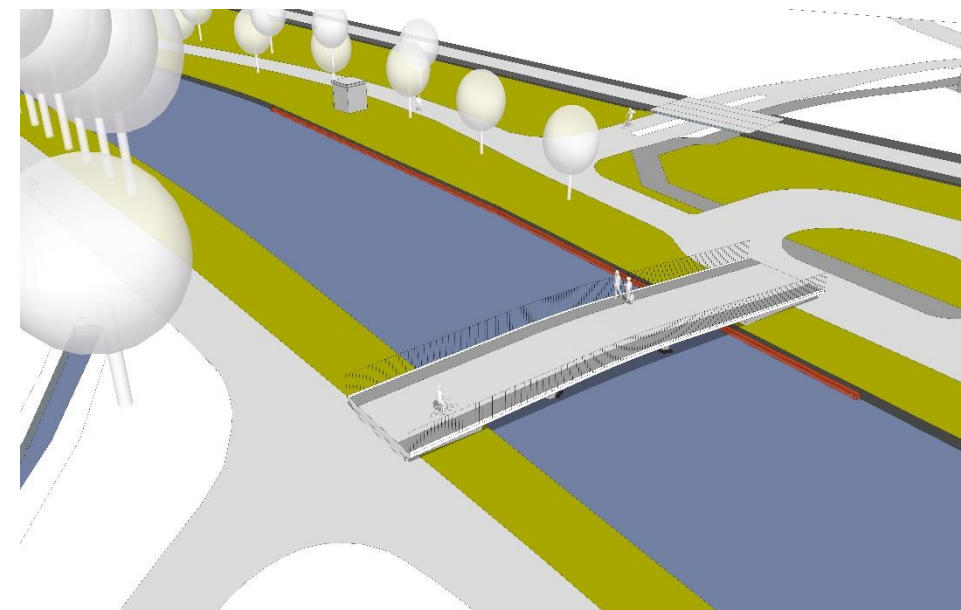

5. in verlengde van zijstraat

**beperkingen locatie**

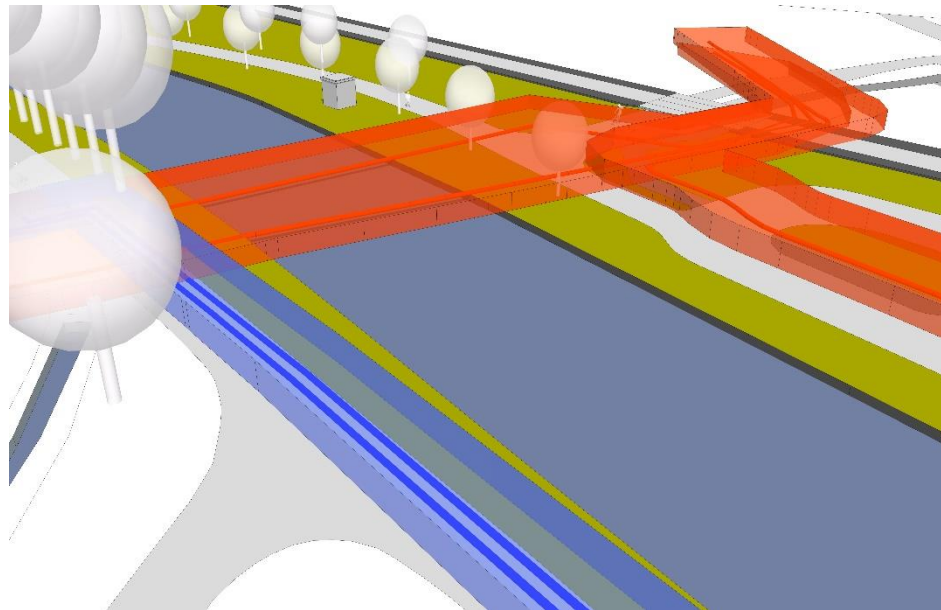

kabels en leidingen

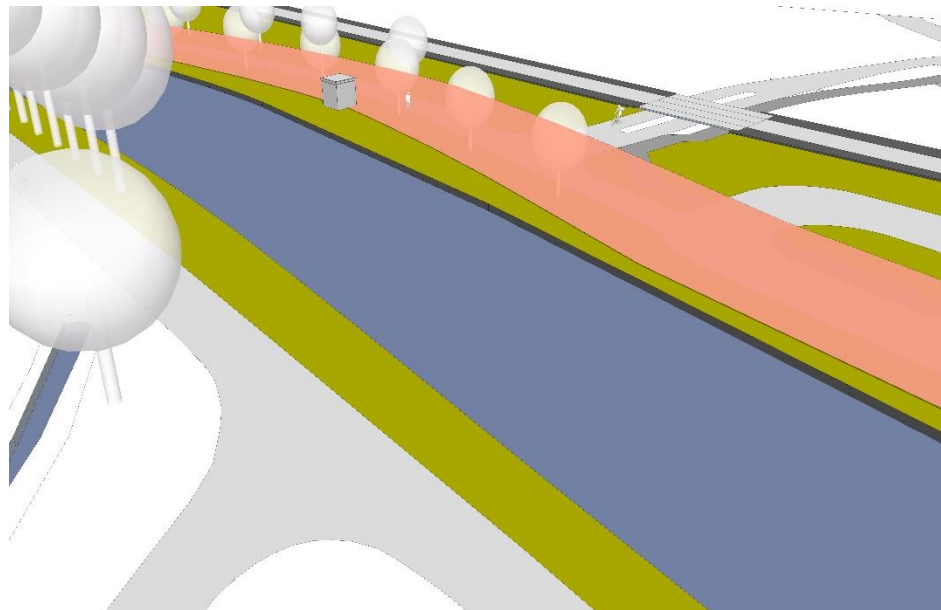

waterkering

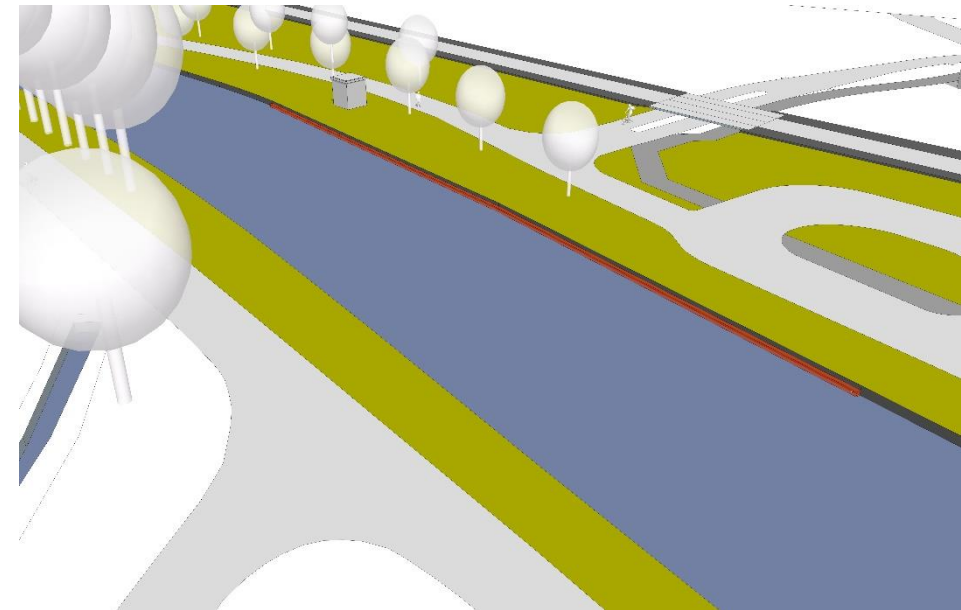

aanlegvoorziening

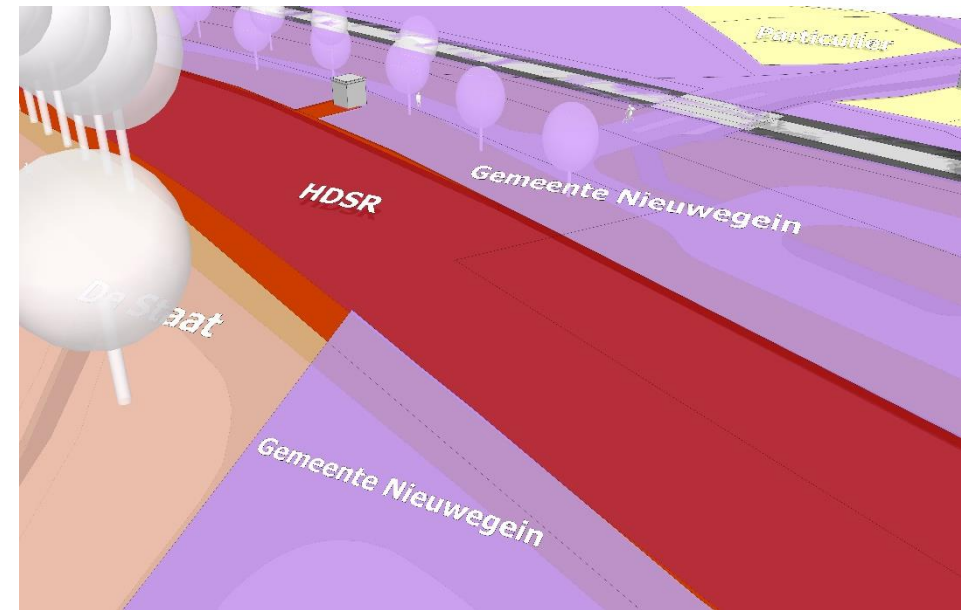

eigendommen

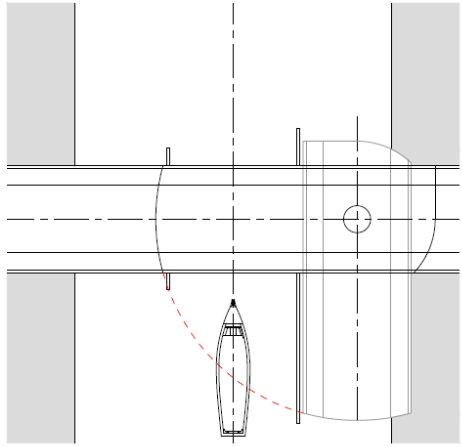

afb. 28 - draaibrug

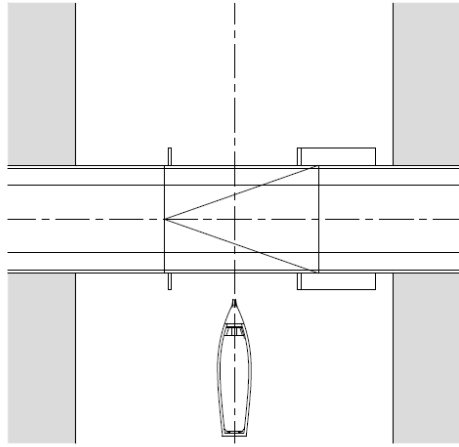

afb. 29 - basculebrug

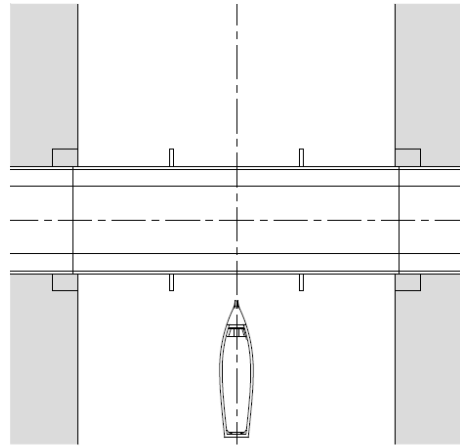

afb. 30 - hefbrug / tafelbrug

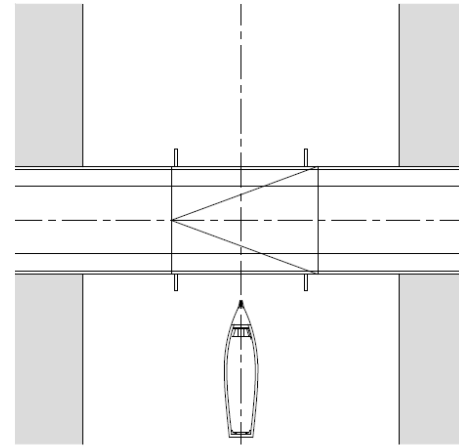

afb. 31 - klapbrug

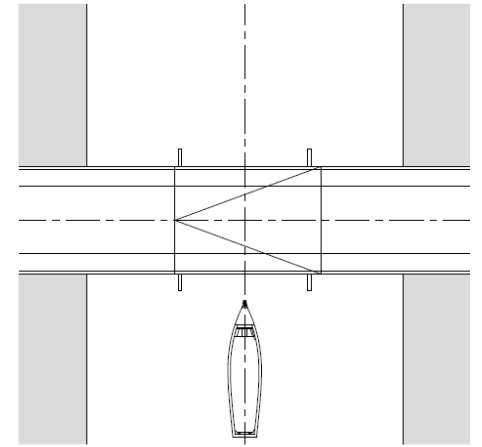

afb. 32 - ophaalbrug

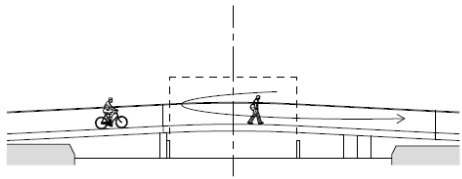

draaibrug

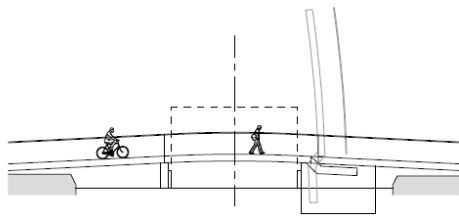

basculebrug

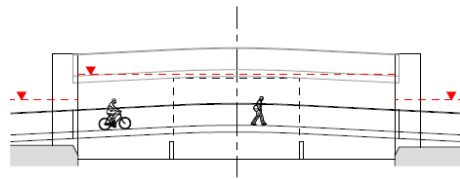

hefbrug

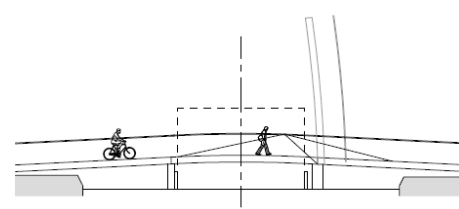

klapbrug

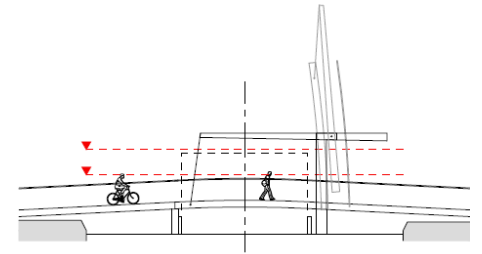

ophaalbrug

**type brug**

hefbrug

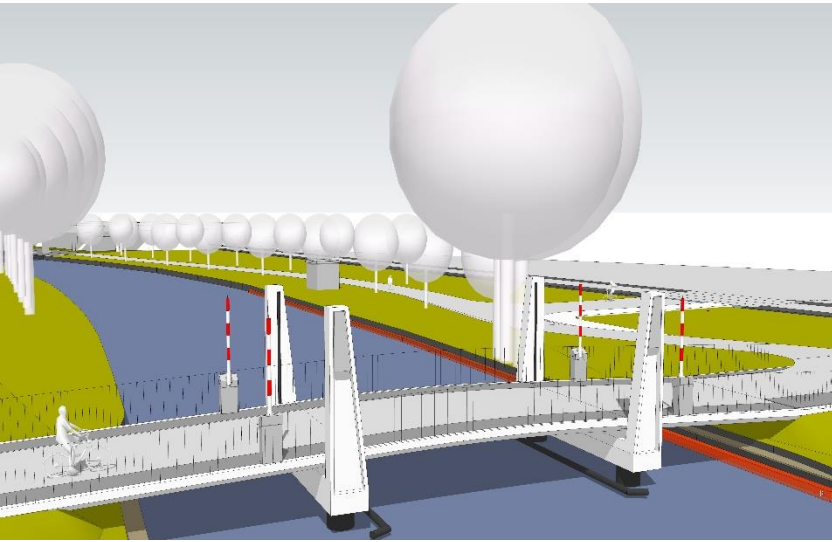

klapbrug

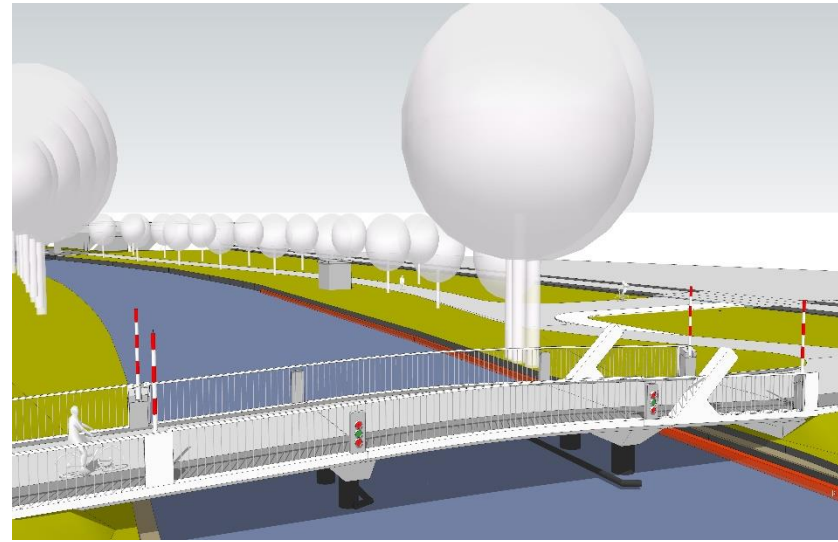

ophaalbrug

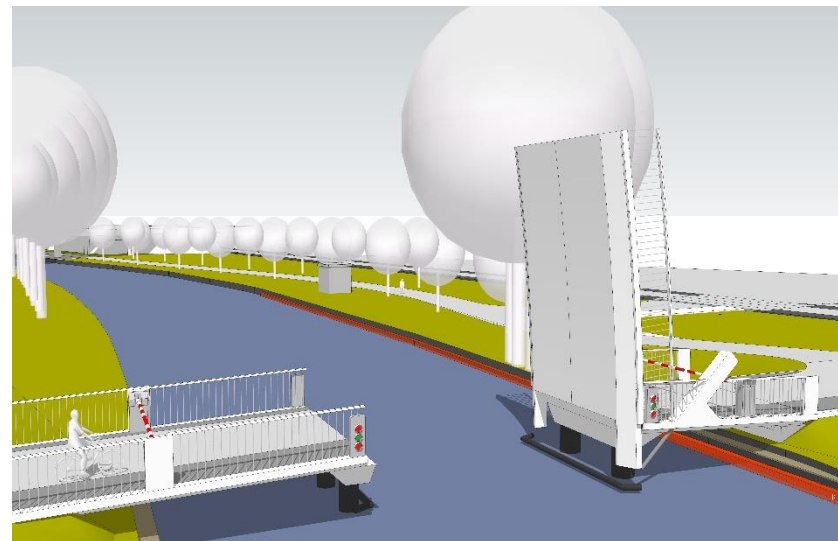
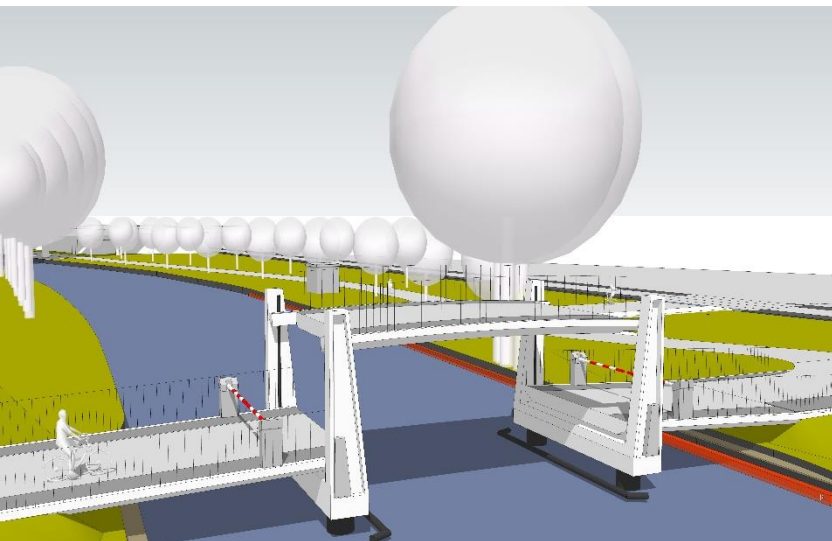
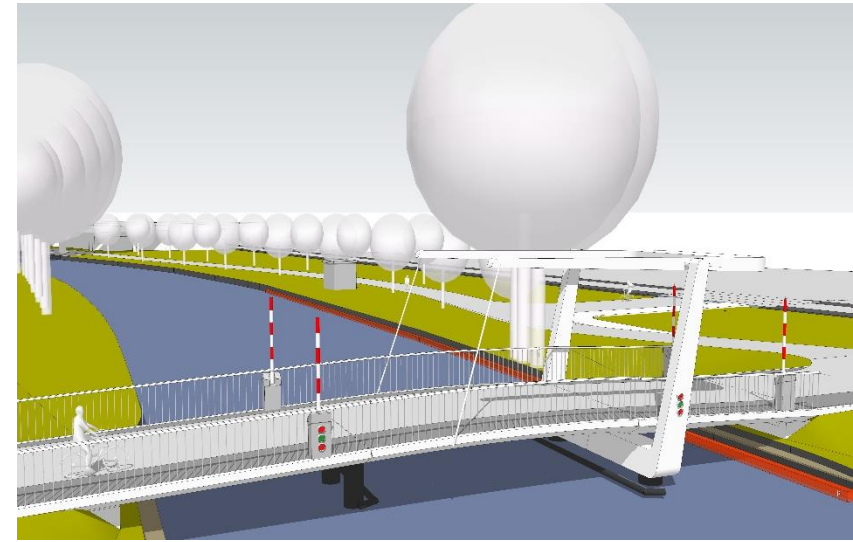

drie geschikte types

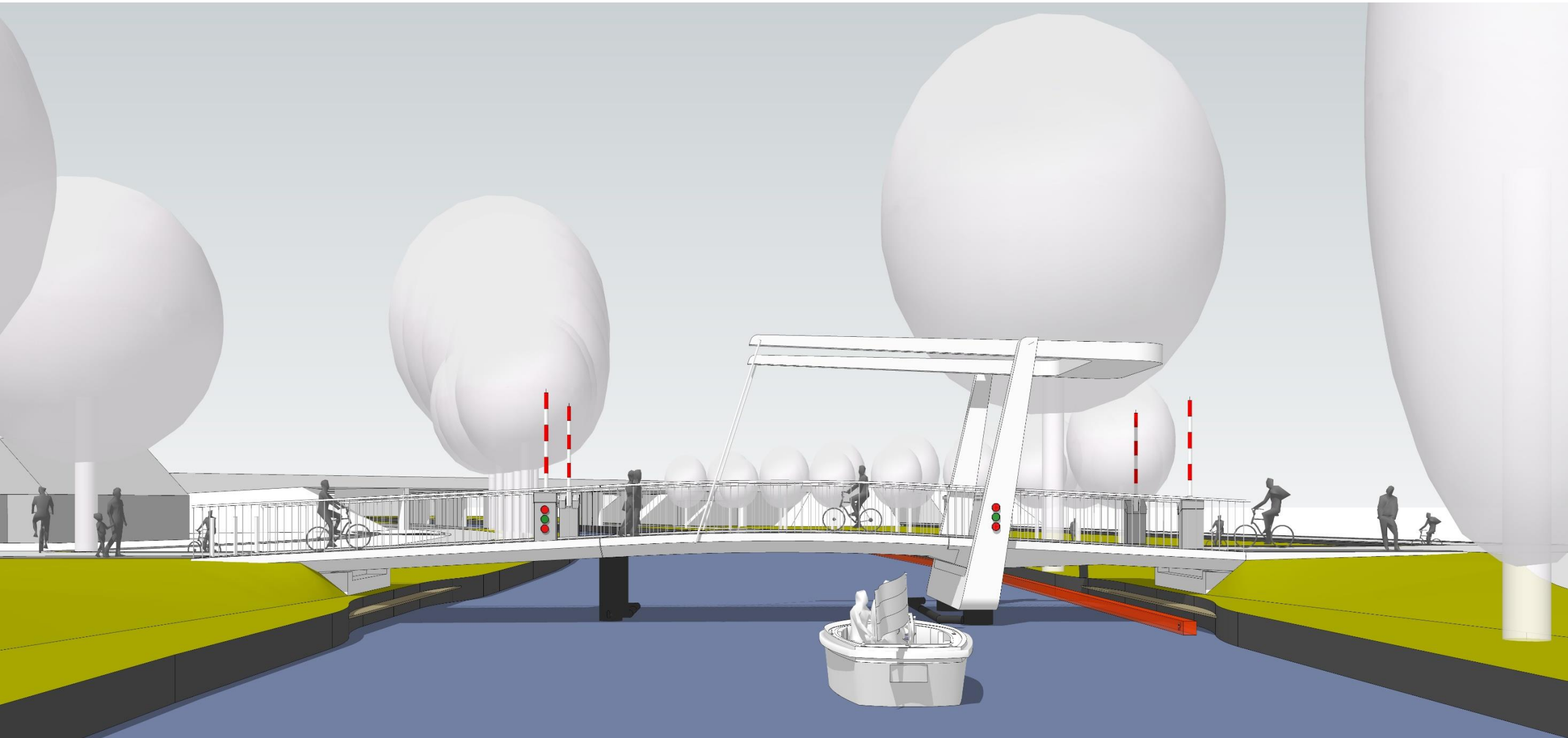

aanzicht

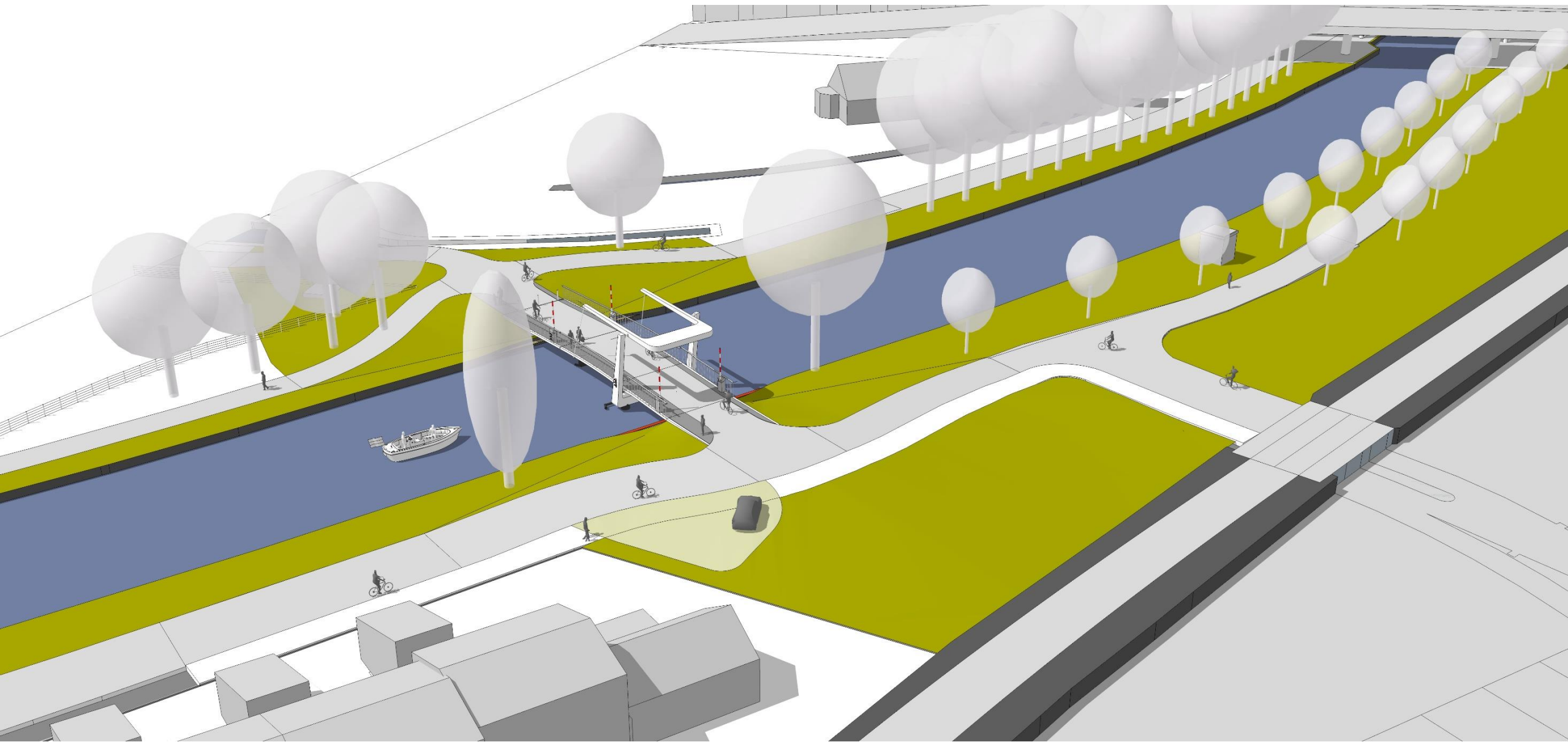

vogelvlucht

Deel 3 - Hans



*hoe nu verder*

vragen...

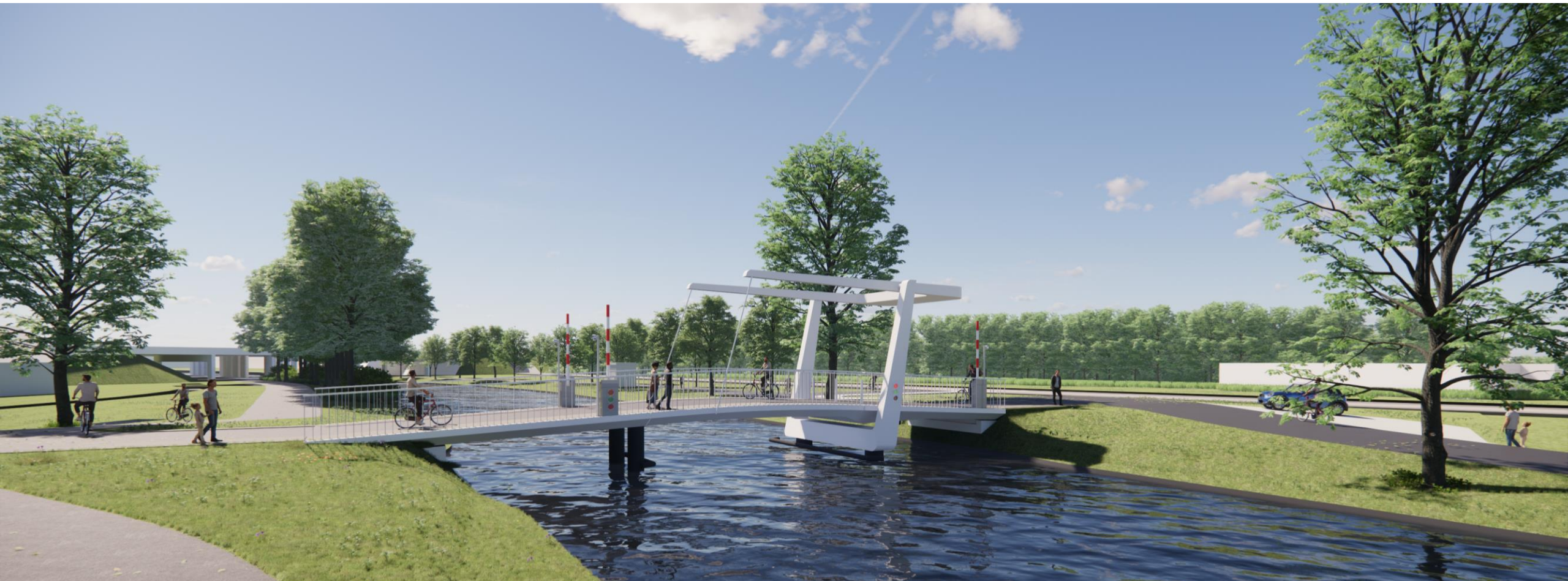



vragen...

